



HPR Battery V02 250 Wh



User Manual
EN

1 Safety



These instruction contains information that you must observe for your personal safety and to prevent personal injury and damage to property. They are highlighted by warning triangles and shown below according to the degree of danger.

- ▶ Read the instructions completely before start-up and use. This will help you to avoid hazards and errors.
- ▶ Keep the manual for future reference. This user manual is an integral part of the product and must be handed over to third parties in case of resale.

NOTE

Also observe the additional documentation for the other components of the HPR50 drive system as well as the documentation enclosed with the e-bike.

1.1 Hazard classification

DANGER

The signal word indicates a danger with a **high** degree of risk which will result in death or serious injury if not avoided.

WARNING

The signal word indicates a danger with a **medium** level of risk which will result in death or serious injury if not avoided.

CAUTION

The signal word indicates a danger with a **low** level of risk which could result in a minor or moderate injury if not avoided.















NOTE

A note in the sense of this instruction is important information about the product or the respective part of the instruction to which special attention is to be drawn.

1.2 IMPORTANT SAFETY INSTRUCTIONS





WARNING

When using this product, basic precautions should always be followed, including the following:

-  Read all the instructions before using the product.
-  Do not put fingers or hands into the product.
-  Liquid may leak from the Battery if used improperly. Avoid any contact with this liquid. Wash it off with water if you do come into contact with the liquid. Also seek medical attention if the liquid has come into contact with your eyes. Liquid leaking from the Battery can cause irritation or burns.
-  Never subject the Battery to mechanical shocks to prevent damage to the Battery.
-  To reduce the risk of injury, close supervision is necessary when the Battery is used near children.
-   Never open the Battery case or attempt to disassemble the Battery.
-  Do not use this product if the flexible power cord or output cable is frayed, has broken insulation, or any other signs of damage.
-  Never break or puncture the Battery.
-  Only charge the Battery in well ventilated rooms.
-  Only use the original TQ Charger (FSP235-14S4AC8C) to charge the Battery.
-  Use only original HPR Batteries to supply power to the drive system.
-  This equipment is not intended to be used at ambient temperatures less than -5 °C (23 °F) or above ambient temperatures of 40 °C (104 °F).
-  The battery is intended to be charged when the ambient temperature is between 0 °C (32 °F) and 40 °C (104 °F). Never charge the battery when ambient temperatures are outside this range.
-  Do not attempt to modify or repair the product. Check further detail in Chapter "1.3 Intended Use".

-  Only use this product within following temperature limits
Operation: -5 °C to 40 °C / 23 °F to 104 °F
Charging: 0 °C to 40 °C / 32 °F to 104 °F
Storage: 0 °C to 40 °C / 32 °F to 104 °F
Recommended storage: 10 °C to 20 °C / 50 °F to 68 °F

1.2.1 INSTRUCTIONS PERTAINING TO RISK OF FIRE

-  **Explosion and fire hazard with damaged Battery housing**
 - If the Battery housing is damaged, make sure to have it replaced by a TQ authorised bicycle dealer, even if the Battery is still functional.
 - Do not make any repair attempts under any circumstances.
-  **Explosion and fire hazard when short-circuiting the Battery terminals**
 - Keep the Battery away from metallic objects as there is a risk of short circuits. Do not allow nails, screws or other small, sharp and/or metallic objects to come into contact with the Battery (charging/ discharging socket).
-  **Risk of explosion and fire in case of high heat, fire or contact with water**
 -  Protect the battery from fire, high heat and also from extended direct exposure to sunlight.
 - Never immerse the battery in water.
-  **Danger of poisoning by gases from a smoking or burning Battery in case of damaged Battery or improper use.**
 - Be careful not to breathe in the highly toxic gases from a smoking or burning Battery.
 - Ensure good ventilation and consult a doctor if you notice any undesirable effects on the respiratory organs. The vapors may irritate the respiratory organs.

1.2.2 INSTRUCTIONS PERTAINING TO ELECTRIC SHOCK

-  **The Electric risk and shock is only applicable for the TQ Charger (FSP235-14S4AC8C). Please check and read all safety instruction which are included in the Charger manual.**

SAVE THESE INSTRUCTIONS

1.3 Intended Use

 The HPR Battery V02 is intended exclusively for supplying power to the HPR50 drive system and must not be used for any other purpose.

Any other use or use that goes beyond this is considered improper and will result in the loss of the warranty. In case of non-intended use, TQ-Systems GmbH assumes no liability for any damage that may occur and no warranty for proper and functional operation of the product.

Intended use also includes observing these instructions and all the information contained therein as well as the information on intended use in the supplementary documents enclosed with the e-bike.

Faultless and safe operation of the product requires proper transport, storage, installation and operation.

2 Technical data

Nominal voltage	50.4 V
Nominal capacity	4.9 Ah
Nominal energy	360 Wh
Dimensions	39 mm x 63.5 mm x 420 mm / 1.53" x 2.5" x 16.53"
Charging temperature	0 °C to 40 °C / 32 °F to 104 °F
Operating temperature	-5 °C to 40 °C / 23 °F to 104 °F
Storage temperature	0 °C to 40 °C / 32 °F to 104 °F
Recommended storage temperature	10 °C to 20 °C / 50 °F to 68 °F
Weight	approx. 1350 g / 2.98 lbs

Tab. 1: Technical data – HPR Battery V02

3 OPERATION

3.1 Battery charging

DANGER

- ▶ Only use TQ Charger (FSP235-14S4AC8C) for charging the Battery.

WARNING

Fire or electric shock hazard due to damage to Battery, Range Extender, charger, cable and plug

- ▶ Never charge the Battery if you notice any damage to the Battery, Range Extender, charger, cables or connectors.
- ▶ Only perform the charging process in a place where there are no flammable materials in surrounding.
- ▶ Never leave the charging process unattended.
- ▶ Do not attempt to modify or repair the product. Check further detail in Chapter "1.3 Intended Use".
- ▶ Only use this product within following temperature limits:
Operation: -5 °C to 40 °C / 23 °F to 104 °F
Charging: 0 °C to 40 °C / 32 °F to 104 °F
Storage: 0 °C to 40 °C / 32 °F to 104 °F
Recommended storage: 10 °C to 20 °C / 50 °F to 68 °F
- ▶ Further safety warnings regarding Risk of Fire, Electric Shock or Injury to persons can be found in the section: "1.2 Important Safety Instructions".

NOTE

You can charge the Battery either directly with the charger or via the optional Range Extender. For more information, refer to the corresponding user manuals for the charger and the Range Extender.

- ▶ Connect the charger to the power supply.
- ▶ Unfold the cover (pos. 1 in Fig. 1) on the charging port (pos. 2 in Fig. 1) in the bike frame.
- ▶ Check that the contacts in the charging port are free of dirt and clean them if necessary.
- ▶ Align the charging plug (pos. 3 in Fig. 1) of the charger or Range Extender so that the plug codes of the charging plug and charging port match (see Fig. 1).

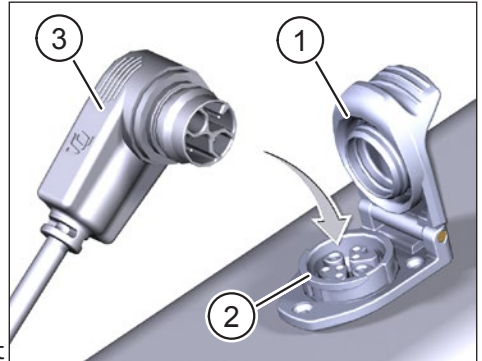

Fig. 1: Battery charging

- ▶ Insert the charging plug (pos. 3 in Fig. 1) of the charger or Range Extender into the charging port.
- ▶ Pull the charging plug out of the charging port when charging is complete.
- ▶ Close the cover on the charging port when charging is complete and disconnect the charger from the power supply.

3.2 Note on Charging

NOTE

The temperature of the Battery must be within the permissible charging temperature range (0 °C to 40 °C / 32 °F to 104 °F). Otherwise the charging process will not be started.

- The drive system is deactivated during the charging process.
- The state of charge of the Battery can be read on the Display.
- The state of charge of the Range Extender can be read on the Display and on the 5 LEDs on the side of the Range Extender.
- New batteries have a charge level of 20 % to 30 % due to transportation regulations and must be recharged within less than 6 months of manufacture.
- The Battery should be recharged immediately after complete discharge (state of charge <5 %).
- 1 charge cycle can consist of a full charge of the Battery capacity (0 % to 100 %) or several partial charges that add up to 100 % of the charge capacity.
- The Battery capacity should be at least 60 % after 500 charging cycles.
- Derating: In case the Battery capacity gets almost empty (approx. <10 %) during riding the systems switches automatically to mode I.

4 TRANSPORT

- The transport of lithium batteries is subject to country-specific laws and regulations. Inform yourself about the respective regional regulations and observe them during transport.
- For transport observe the special requirements for packaging and labeling that apply in your country.
- Contact a TQ authorized bicycle dealer for information on transporting the Battery and suitable transport packaging. For transport outside the bicycle frame, we recommend a certified transport box.

5 STORAGE

- It's recommended to store the Battery at room temperature (approx. 10 °C to 20 °C / 50 °F to 68 °F) and do not expose it to direct sunlight.
- Do not store the Battery near heat sources or other easily flammable materials.
- Store the Battery in dry rooms (humidity below 70 %) and protect it from rain and moisture.
- Store the Battery only in rooms equipped with smoke detectors.
- Charge the Battery to approx. 30 % to 60 % before storage.
- Check the Battery every 6 months and recharge it to approximately 30 % to 60 %.
- Fully charge the Battery before use.
- Do not store the Battery with the charger plugged in.

6 USER MAINTENANCE

6.1 Maintenance and Service

All service, repair or maintenance work performed by a TQ authorized bicycle dealer. Your bicycle dealer can also help you with questions about bicycle use, service, repair or maintenance.

6.2 Cleaning

- Never immerse the Battery in water to clean it.
- Never clean the Battery with a water jet.
- Only clean the Battery with a soft, damp cloth.
- Please contact a TQ authorised bicycle dealer, if the Battery is no longer functional.

7 Environmentally friendly disposal

The components of the drive system and the batteries must not be disposed of in the residual waste garbage can.



- Dispose of metal and plastic components in accordance with country-specific regulations.
- Dispose of electrical components in accordance with country-specific regulations. In EU countries, for example, observe the national implementations of the Waste Electrical and Electronic Equipment Directive 2012/19/EU (WEEE).
- Dispose of batteries and rechargeable batteries in accordance with the country-specific regulations. In EU countries, for example, observe the national implementations of the Waste Battery Directive 2006/66/EC in conjunction with Directives 2008/68/EC and (EU) 2020/1833.
- Observe additionally the regulations and laws of your country for disposal.

In addition you can return components of the drive system that are no longer required to a bicycle dealer authorized by TQ.



NOTE

For more information and TQ product manuals in various language, please visit www.tq-ebike.com/en/support/manuals or scan this QR-Code.



We have checked the contents of this publication for conformity with the product described. However, deviations cannot be ruled out so that we cannot accept any liability for complete conformity and correctness.

The information in this publication is reviewed regularly and any necessary corrections are included in subsequent editions.

All trademarks mentioned in this manual are the property of their respective owners.

Copyright © TQ-Systems GmbH